

F2 2x

F1 2x

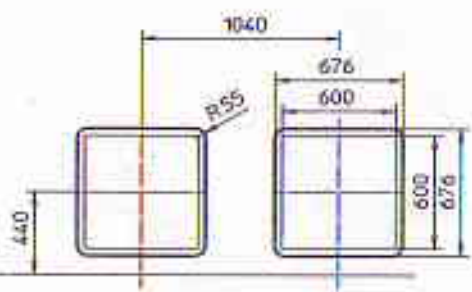
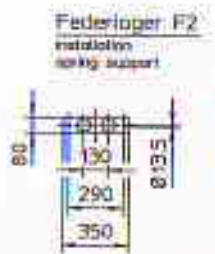
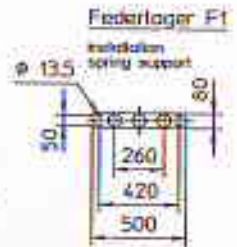
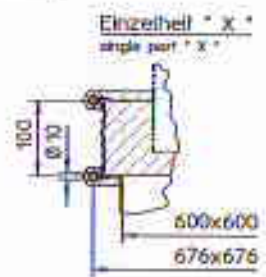
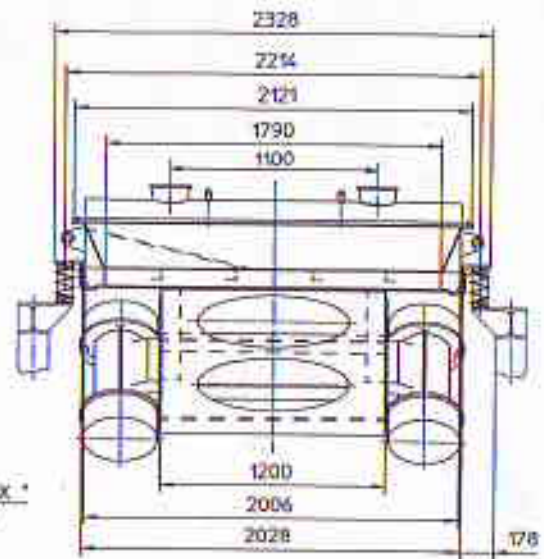
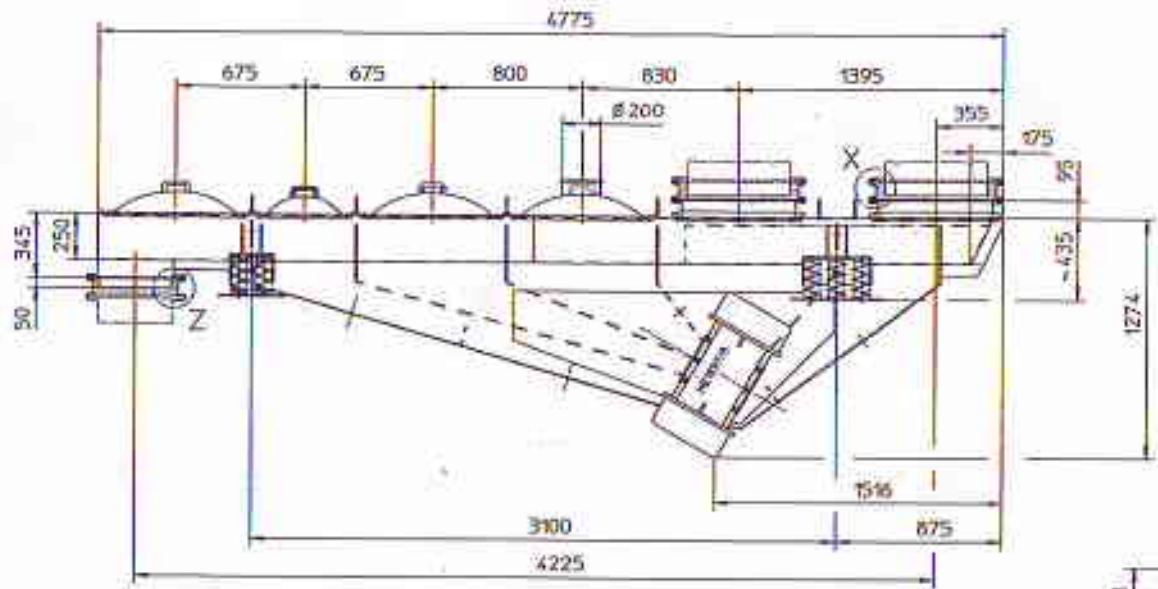

Form der Abgabebestützen  
form of outlet nozzle  
forme de sortie / door width

Form des Aufgabebestützen  
form of inlet nozzle  
forme de prise / door width

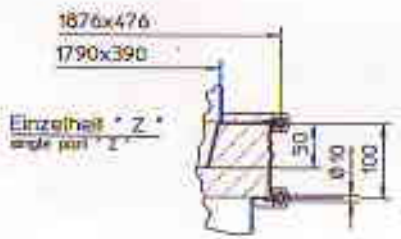

F2	Verlagerungspunkte		F1
F2	Supporting points		F1
F2	Points de support		F1
Höchstzulassung zu stationären Teilen 80 mm			
Maximum distance to stationary parts 80 mm			
Distanza massima dai elementi stazionari 80 mm			

Betriebsbelastung		Operation load		Charge au service	
F1	4545	4075	F1	4545	4075
F2	6022	730	F2	6022	730
Frequenz/Frequency/Frequency Hz/Hz					
Gewicht/weight/Weight kg					

<b>MOGENSEN</b>					
D-22880 Model					
<b>Förderrinne</b>					
TYP: FX845					
10.02M.FX18					